

Uno 5 =mm

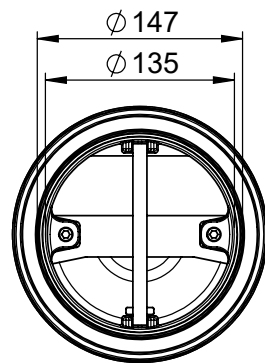

Uno 5 =mm AIR

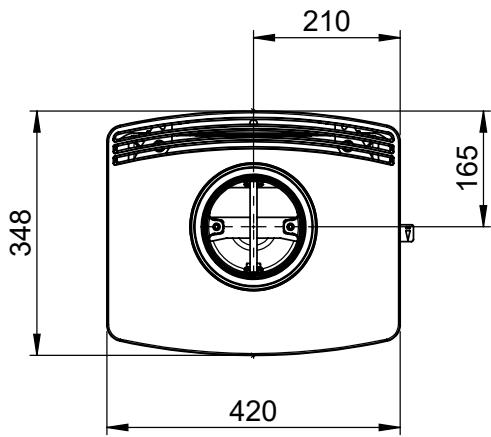
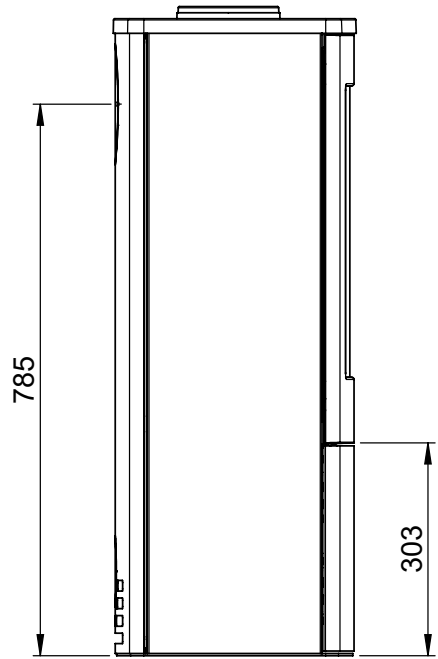
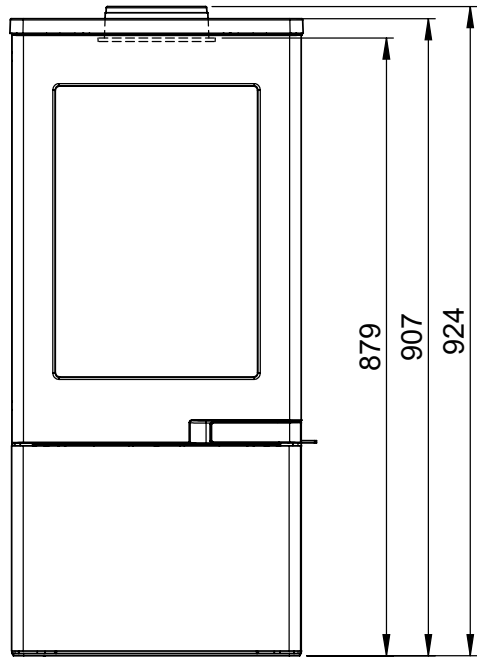